

1 . Features

- 4 Pin SIL Package
- Low Ripple And Noise
- Input / Output Isolation : 3000 Vdc
- 100% Burn-In
- Input Filter With Internal Capacitor
- Custom Design Available
- Net Weight: 1.4 g / 1.8 g Typical
- RoHS Converter Certified By SGS

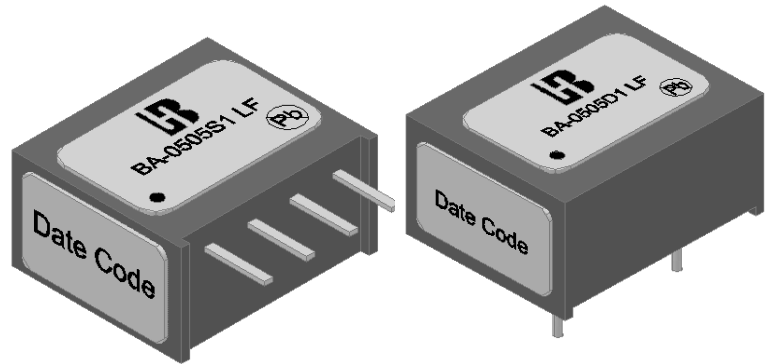

2 . Model Selection Guide

(Specifications typical at Ta= +25°C, Nominal input voltage, Rated output current unless otherwise noted)

Model No.	Input Voltage (Vdc)	Output Voltage (Vdc)	Output Current (mA) Max	Input Current @No Load (mA) Typ.	Input Current @Max. Load (mA) Typ.	Output Ripple (mV) Max.	Load Regulation (%) Max.	Efficiency (%)Typ.
1) 0.5 W Single Output SIL Package Style								
BA-053R3SH LF	5	3.3	150	28	133	50	± 12	74
BA-0505SH LF		5	100	28	135	60	± 10	74
BA-0512SH LF		12	42	28	133	100	± 8	76
BA-1205SH LF	12	5	100	18	56	60	± 8	74
BA-1212SH LF		12	42	18	55	100	± 8	76
BA-2405SH LF	24	5	100	5	29	60	± 8	72
3) 1.0 W Single Output SIL Package Style								
BA-053R3S1H LF	5	3.3	300	30	267	50	± 10	74
BA-0505S1H LF		5	200	30	253	60	± 8	79
BA-0512S1H LF		12	100	30	307	100	± 8	78
BA-1205S1H LF	12	5	200	14	105	60	± 8	79
BA-1212S1H LF		12	84	14	105	100	± 8	79
BA-2405S1H LF	24	5	200	5	54	60	± 8	77

Notes: Load regulation is for output current change from 20% to 100% Max. Load.

3 . Absolute Maximum Ratings

(Exceeding these values may damage the module. These are not continuous operating ratings)

Parameter	Condition	Min.	Typ.	Max.	Unit
Input Absolute Voltage Range	5V Input Model	- 0.7	5	7.5	Vdc
	12V Input Model	- 0.7	12	15	
	24V Input Model	- 0.7	24	30	
Max. Output Power		---	---	1.0	W
Output Short Circuit Duration		---	---	1.0	Second
Operation Temperature (Ambient Temperature)	Output Full Load	- 40	---	+ 85	°C
Operation Temperature (Case Surface Temperature)		-40	---	+95	
Storage Temperature		-55	---	+105	

4 . Nominal Input/Output Electrical Specifications

(Specifications typical at Ta= +25°C ,Nominal input voltage, Rated output current unless otherwise noted)

Parameter	Condition	Min.	Typ.	Max.	Unit	
Input Voltage Range	5V Input Model	4.5	5	5.5	Vdc	
	12V Input Model	10.8	12	13.2		
	24V Input Model	21.6	24	26.4		
Line Regulation (Per1.0% change in input change)		---	---	1.3	%	
Output Voltage Accuracy	Nominal Input	---	---	± 5.0		
Voltage Balance (Dual Outputs)		---	---	± 1.0		
Switching Frequency		---	100	---		KHz
Temperature Coefficient		---	± 0.01	± 0.02		%/ °C
Isolation Voltage	60 Second/0.5mA	1000	---	---	Vdc	
Isolation Resistance	500Vdc	1000	---	---	MΩ	
Isolation Capacitance	1KHz / 250mV rms	---	40	---	pF	

5 . General Specification

Parameter	Specification	Condition
Isolation Voltage	1000 Vdc	Test Duration 60 Seconds / 0.5 mA
Isolation Resistance	1000 MΩ Min.	@ 500 Vdc
Humidity	Up To 90 %	---



Cooling	Free Air Convection	---
Case Type	Plastic	---

6 . Ordering Information

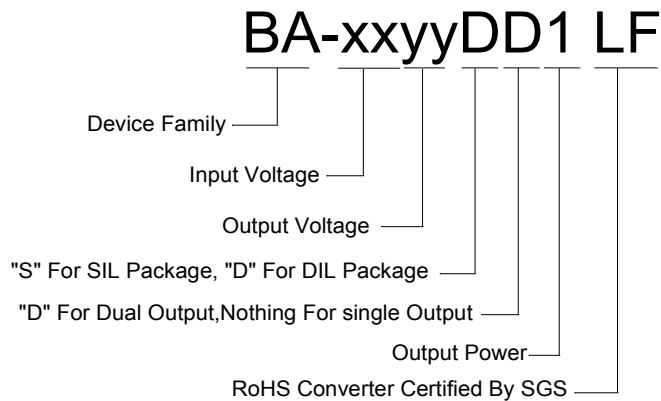

7 . Power Derating Curve

Temperature derating graph

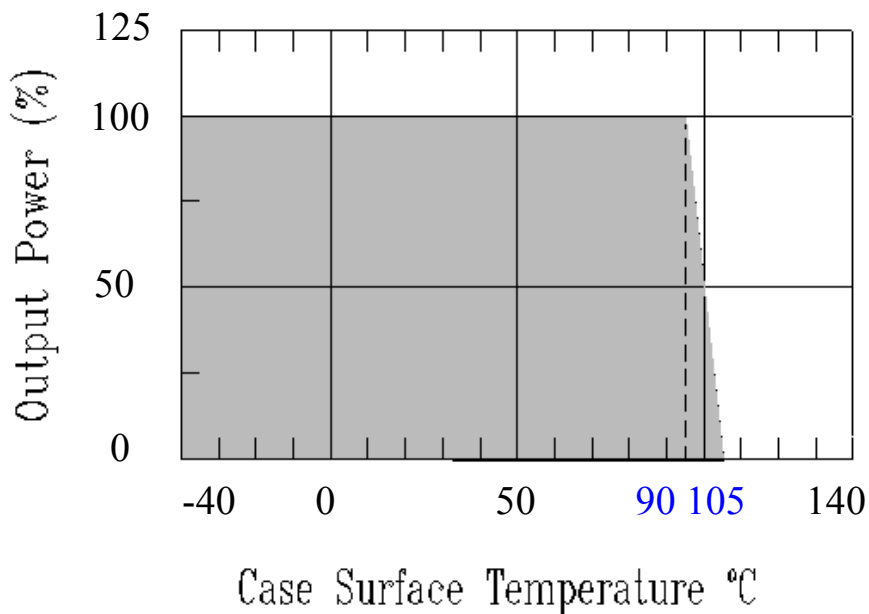

8 . Efficiency & Output Load Chart

Vout = 3.3 Vdc

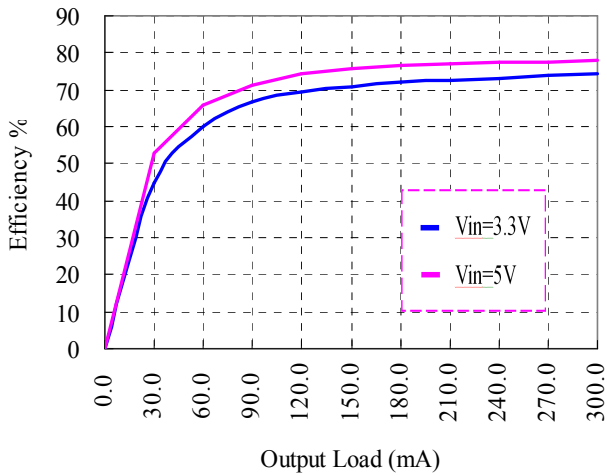

Vout = 5 Vdc

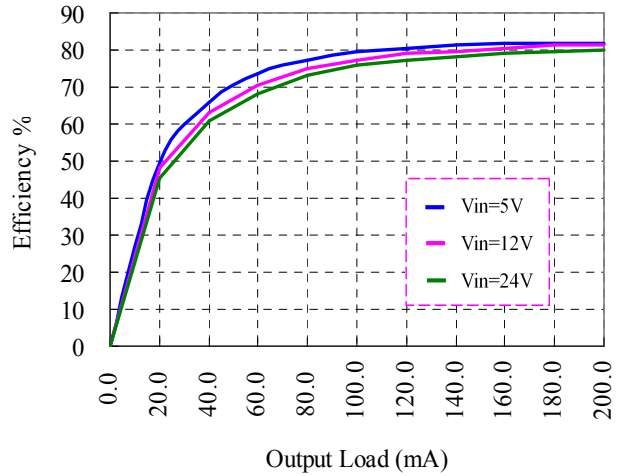

Vout = 12 Vdc

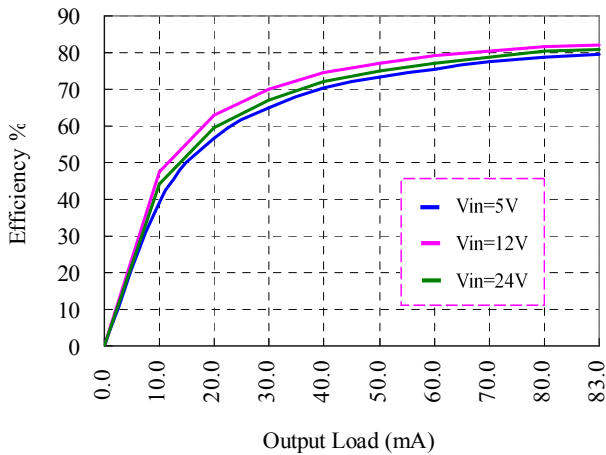

Vout = 15 Vdc

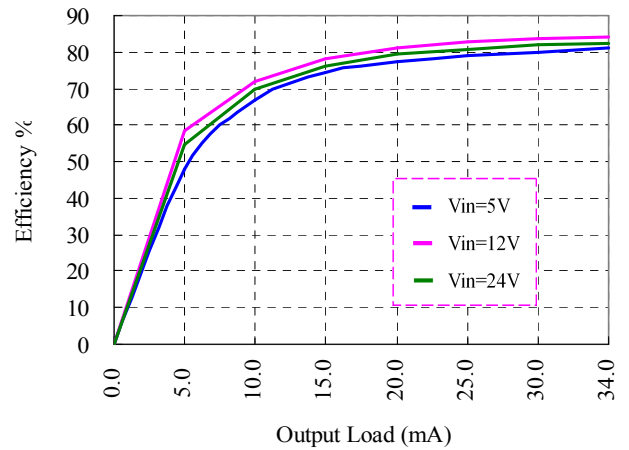

9 . Mechanical Dimension

Single Output SIL Package Style

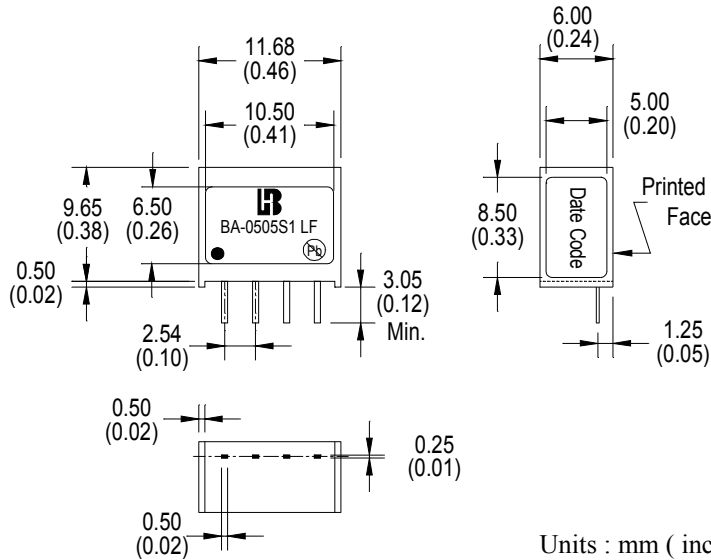

Pin	1K Vdc - Single
1	-Vin
2	+Vin
3	-Vo
4	+Vo

Units : mm (inch)
Tolerance : .xx ± 0.25 (± 0.01)

Single Output DIL Package Style

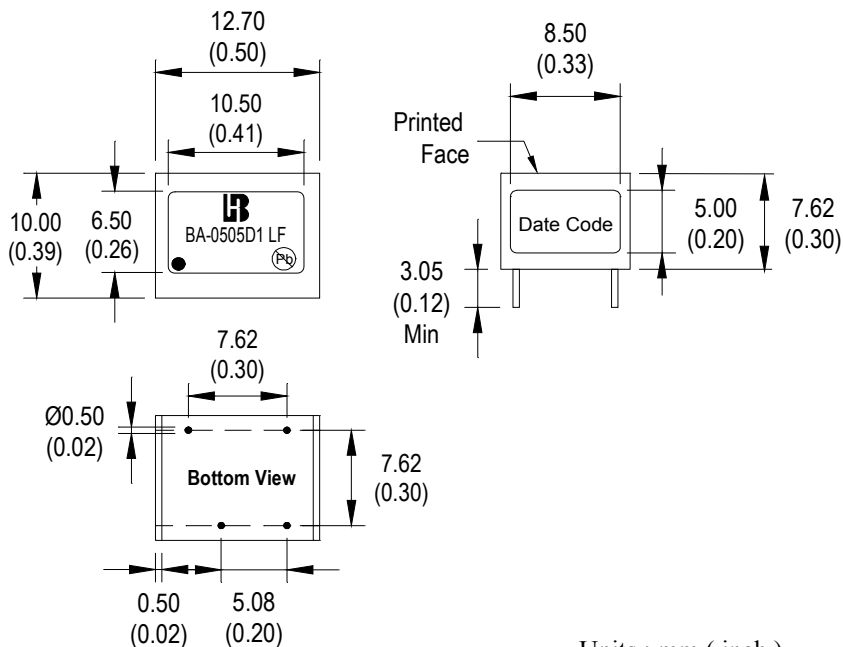

Pin	1K Vdc - Single		Pin
1	-Vin	No Pin	8
2	No Pin	-Vo	7
3	No Pin	No Pin	6
4	+Vin	+Vo	5

Units : mm (inch)
Tolerance : .xx ± 0.25 (± 0.01)

Dual Output DIL Package Style

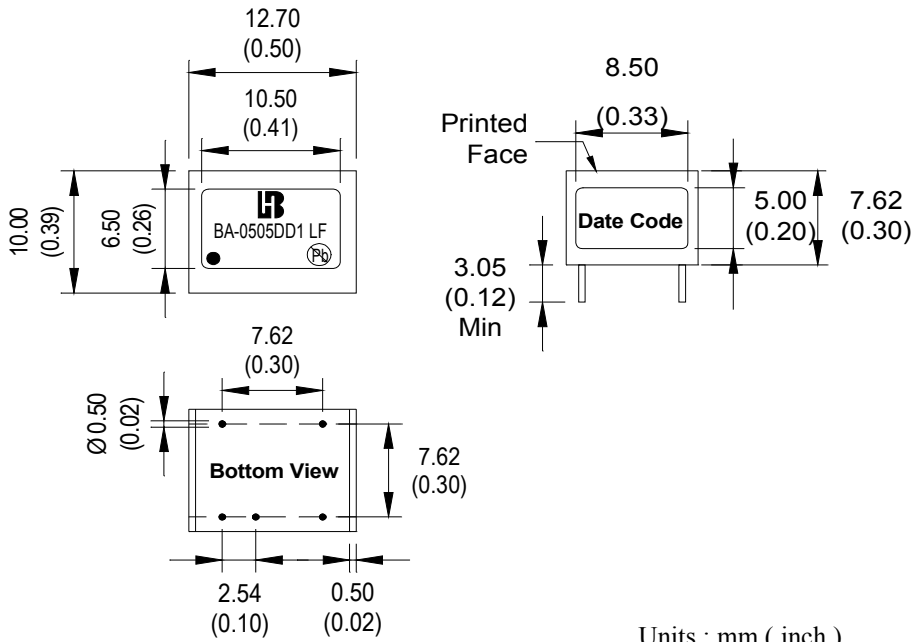

Pin	1K Vdc - Dual		Pin
1	-Vin	-Vo	8
2	No Pin	Common	7
3		No Pin	6
4	+Vin	+Vo	5

Units : mm (inch)
Tolerance : .xx ± 0.25 (± 0.01)

10. Recommended Footprint Details

SIL Package Style

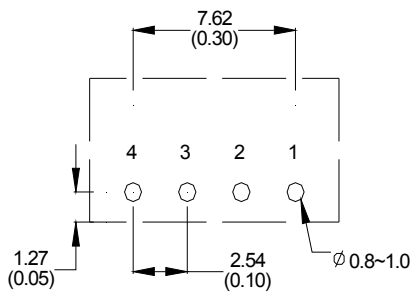

DIL Package Style

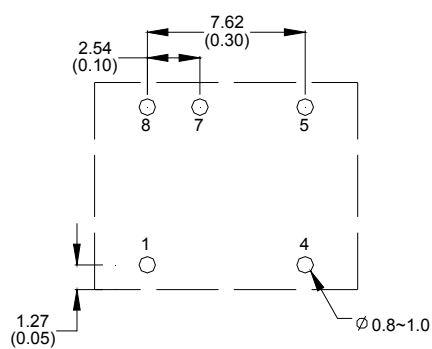

Units : mm (inch)
Tolerance : .xx ± 0.25 (± 0.01)

11. Package



Bothhand Enterprise Inc.

<http://www.bothhand.com.tw>

E-mail: Sales@bothhand.com.tw

SIL Package Style

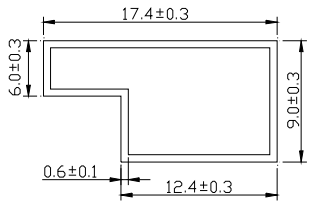

TUBE MECHANICAL DIMENSION

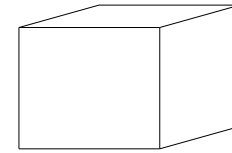
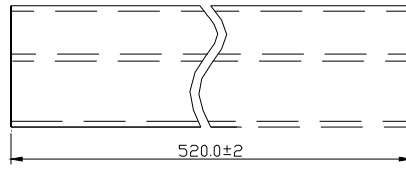

INNER CARTON:565*115*117

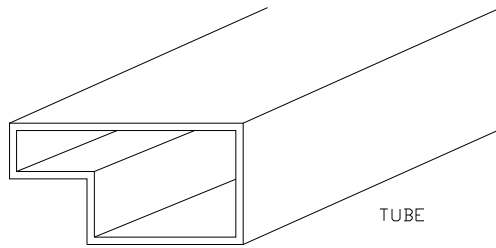

TUBE

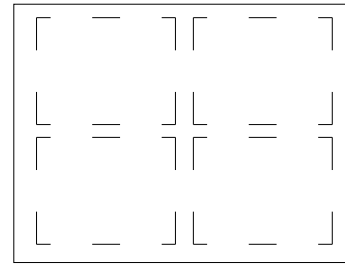

EXPORT CARTON:580*255*265

1. TUBE=41PCS
2. INNER CARTON=50 TUBE=50*41=2050PCS
3. EXPORT CARTON=4 INNER CARTON=4*2050=8200PCS

DIL Package Style

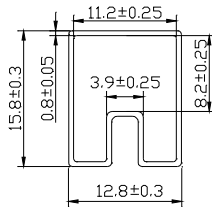

TUBE MECHANICAL DIMENSION

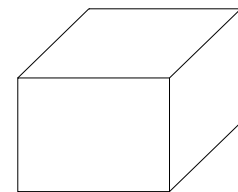
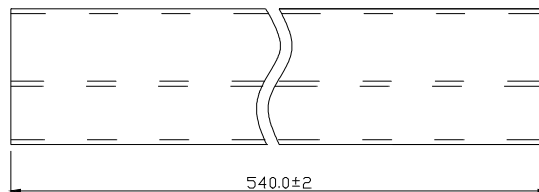

INNER CARTON:575*170*87

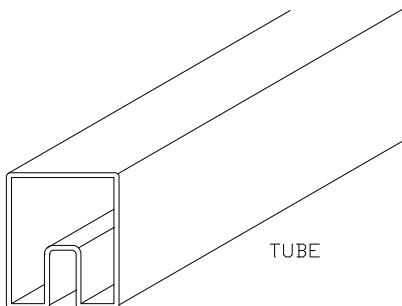

TUBE

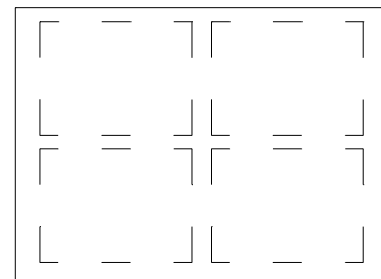

EXPORT CARTON:583*380*210

1. TUBE=40PCS
2. INNER CARTON=50TUBE=50*40=2000PCS
3. EXPORT CARTON=4 INNER CARTON=4*2000=8000PCS